



JNR D ESIGNED LLC

Air Ride Control Module

Note: Read entire instructions before beginning the install process.

1. Determine where to mount the Air Ride Control module.
The module should be mounted in a location that will stay dry and be oriented upside down (label up). Also consider the length of the power/ground wires (with ring terminals), choosing a location within their range of the battery.
2. Install all other air ride components, routing the wiring to the pre-determined location of the control module.
3. Strip all ends of component wires to 1/4" of exposed wire. You can use the dimensionally accurate guide to the right to measure the length of stripped wire.
This is critical to ensure that the wires make good connections, do not come loose from the terminals, and no stripped wire is exposed.
4. Insert the component wires into the terminals per the included wiring guide.

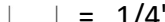

□ = 1/4"

- a. For the spring clamp terminal:
Press and hold the button above the terminal with a small screwdriver to decompress the spring clamp. Insert the wire so that the exposed wire is as far back as possible. See Fig. 1
Ensure that the end of the wire coating is inside the outer edge of the terminal. This will reduce the risk of the wires wiggling loose and prevent short circuits.
See Fig. 2
- b. For the screw cage terminal:
Unscrew the screw at the top to open the cage. Insert the wire as far into the terminal as possible. See Fig. 3
While holding the wire in the terminal, tighten the top screw as tight as possible by hand. See Fig. 4

Fig. 1

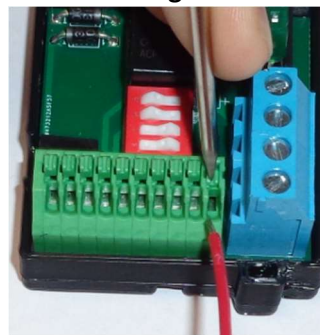

Fig. 2

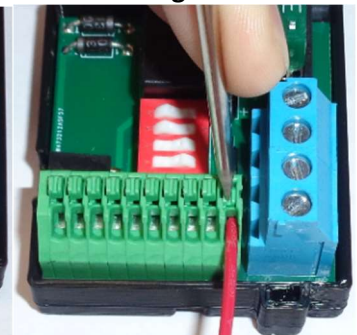

Fig. 3

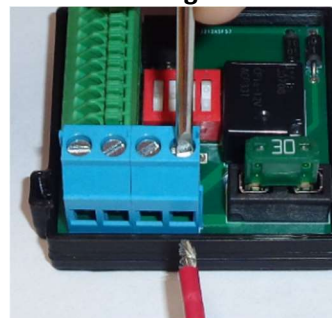
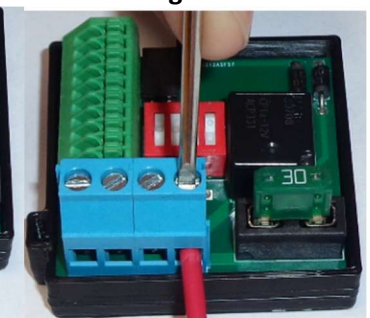
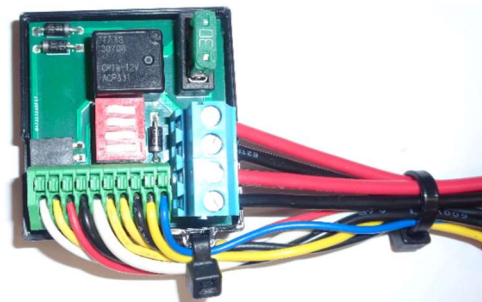

Fig. 4



- c. After inserting each wire, give it a gentle pull to confirm the clamps have good contact with the exposed wire. If the wire is pulled free, restart step 4. If the wire is clamped correctly, but there is exposed wire outside the bounds of the terminal, shorten the length of the exposed wire and then repeat step 4.

5. Once all the wires are connected, group the spring terminal wires together, wrap them around the side of the module with the zip tie tab, and zip tie them in place. **When doing so, avoid putting tension on the wires at the terminals.** Then zip tie this group of wires together along with the four larger wires.



6. Connect the power and ground ring terminals to the battery.



7. Insert the third zip tie through the slot at the bottom of the module box and use it to mount the module in the predetermined location.

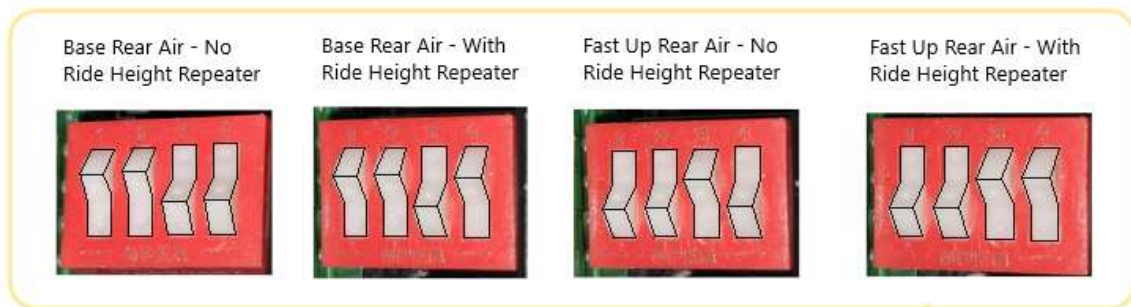

Terminal	Component	Color
1	Rear Down Switch	White
2	Rear Up Switch	Yellow
3	Rear Switch Power (+)*	Red
4	Rear Dump Valve Ground (-)	Black
5	Rear Dump Valve Power (+)	White
6	Ride Height Repeater**	Yellow
7	Ride Height Repeater**	Yellow
8	Rear Fill Valve Ground (-)***	Black
9	Rear Fill Valve Power (+)***	Yellow
10	Pressure Switch***	Blue
11	Battery Ground (-)	Black
12	Battery Power (+)	Red
13	Compressor Ground (-)	Black
14	Compressor Power (+)	Red

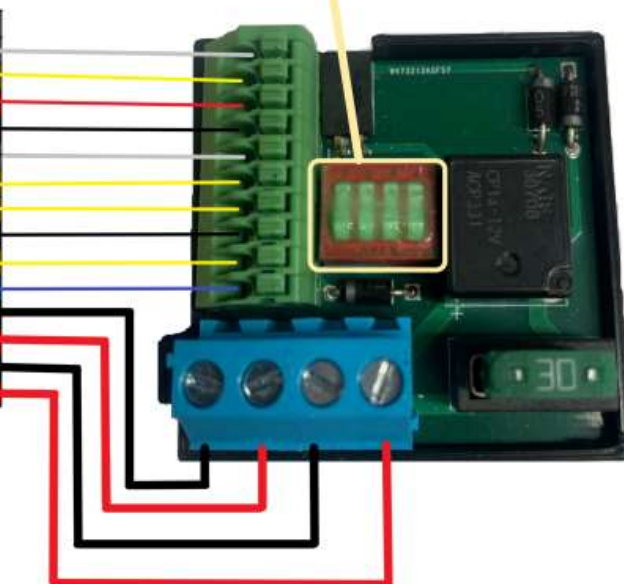

* Empty if using dash switches on 2014 & newer models.

** If equipped.

*** Fast Up only.

Plumbing Diagrams

